



**Page Index**

- Summary	P.1
- Sketches	P.2 - P.3
- Materials	P.4 - P.7
- Sizes	P.8 - P.10
- Fit Sample	P.11 - P.12
- Denim Washes and Treatment	P.13 - P.14

**Members**

- Owner	Lucy Watson
---------	-------------

**Style Info**

Fitted denim jeans with front side pocket and back patch pocket. It has a back yoke panel and belt loops.

- Units: Inches
- Sizes: M
- Sample Size: M
- Color Combo: BLUE



Sketches

Denim - B&W - Back

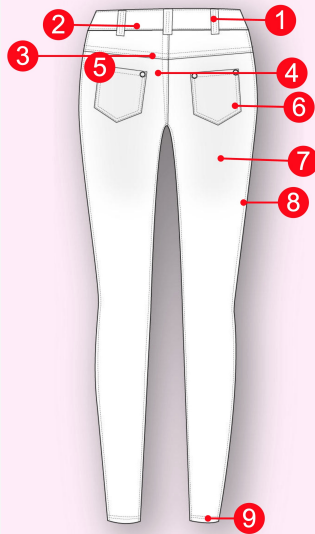

Denim - B&W - Front

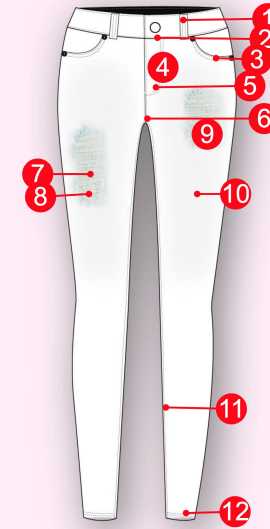

- 1 Belt Loops 1/8" DNS Stitch in Contrast Thread
- 2 1/8" SNS - Contrast thread
- 3 1/8" DNS edge stitch along the back yoke
- 4 1/8" SNS Back Rise Seam
- 5 Rivet
- 6 1/8" SNS front Rise Seam
- 7 Sandblasting
- 8 Sideseam - 1/8" SNS
- 9 DNS Hemline - Contrast thread

- 1 Belt Loops 1/8" DNS Stitch in Contrast Thread
- 2 1/8" SNS - Contrast thread
- 3 1/8" DNS Pocket Edge- Contrast thread
- 4 YKK Zipper Inside Fly
- 5 1/8" DNS Scoop Placket - Contrast thread
- 6 1/8" SNS front Rise Seam
- 7 Grinding and Ripping - Pls dont patch shetting behind holes
- 8 Sandblasting
- 9 Grinding and Ripping - Pls dont patch shetting behind holes
- 10 Sandblasting
- 11 Inside Seam 1/8" SNS- Contrast thread
- 12 DNS Hemline - Contrast thread



Sketches

Denim - Color - Front



Denim - Color - Back

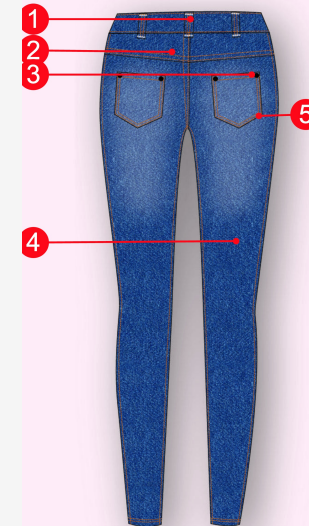

- 1 Main Fabric
- 2 Belt Loops
- 3 Metal Button
- 4 Metal Rivets
- 5 Contrast thread
- 6 Metal Zipper





- 1. Main Fabric - 98% Cotton 2% Elastane
- 2. Belt Loops
- 3. Shank Button - 16MM/26L
- 4. 2.14L rivet - Pocket edges Front - x4
- 5. COATS dual denim thread in Contrast Color
- 6. Metal Zipper - 8" Zipper Along the Centre Front Placket Flap

- 1 Belt Loop
- 2 Back Yoke
- 3 Rivets
- 4 Main Fabric
- 5 Contrast thread

- 1. Main Fabric - 98% Cotton 2% Elastane
- 2. Belt Loops
- 3. 2.14L rivet - Pocket edges Back - x4
- 4. COATS dual denim thread in Contrast Color

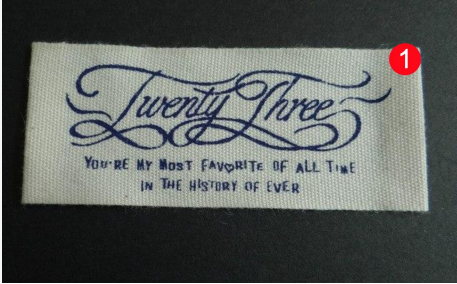

Materials

Metal Rivet	Main Label	Poly Bag
 <p>Close-End Shank Diameter 2.0~3.0mm Shank Length 3~8mm Brass Placement - Front Pocket Edge and Back Patch pocket Edge</p>	 <p>1 Main Label Screen Printing Brand Logo Woven Label 100% Polyester Yarn Damask Weave 2.5" Length X 1" Width Placement - Garment Wrong Side below back Neckline</p>	 <p>1 Plastic Bag Packaging Plastic Bag Non-woven Bag CPP Plastic transparent film 30cm X 40cm</p>
Pocket Bag Fabric	Metal buttons	Red-Orange Thread
 <p>1 Pocket Bag Fabric White 100% Cotton Fabric PANTONE White C Thickness - 150gms Placement - Pocket Bag</p>	 <p>1 Metal button Brass Flatback Round 17mm Placement - Along the Center Front Waistband</p>	 <p>1 COATS thread Red-Orange Thread COATS &amp; CLARK Dual Duty Plus Jeans Thread Cotton-covered polyester thread Along the side seam, hemline, waistband, pocket, Front Zipper</p>



Materials

Metal Zipper



1 Metal Zipper  
 2 DTM Metal Zipper  
 8 Inch  
 Brass metal teeth on a 100% polyester tape  
 Placement - Along Center Front - Denim Fly Flap

Wash Care Tag



1 Wash Care Label  
 Woven Wash Care Label  
 1.5" Width X 4" Length  
 100% Polyester  
 Single sided satin Weave  
 Overlock Stitch to main garment

Denim Fabric

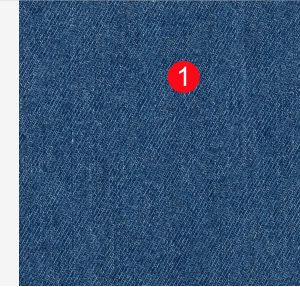

1 Denim Fabric  
 100% Cotton  
 Denim - Mid Weight  
 4.8 oz Denim  
 Chambray Blue Color Reference





201819 2019 DENIM JEANS PANTS

Materials

(\*) Sample size is highlighted in darker green

Description	DESCRIPTION	QUANTITY/ SIZE	QUALITY	PLACEMENT/POSITION	COLOR REFERENCE	BLUE
	Metal Rivet Close-End Shank Diameter 2.0~3.0mm Shank Length 3~8mm	8	Brass	Front Pocket - Edge and Back Patch pocket- Edge	Brass	
	Main Label Screen Printed Brand Logo Woven Label	1 - 2.5" Length X 1" Width	100% Polyester Yarn	Back of Garment		
	Poly Bag Packaging Plastic Bag Non-woven Bag	1	CPP Plastic	Do not poly bag each piece individually.	TRANSPARENT	
	Pocket Bag Fabric Cotton 80 gsm	1/2 Yard	100% Cotton Fabric	Pocket Bag	WHITE C	
	Metal buttons Flatback Round 17mm	1	Brass	Along the Center Front Waistband	Brass	
	Red-Orange Thread COATS & CLARK Dual Duty Plus Jeans Thread	As per Requirement	Cotton-covered polyester thread	Seams	Red Orange	
	Metal Zipper 8 Inch - DTM Metal Zipper	1	8" Brass metal teeth on a 100% polyester tape	Along Center Front - Denim Fly Flap		DTM Tape
	Wash Care Tag Single sided satin Weave Swift Tack through side seam	1 - 1.5" Width X 4" Length	100% Polyester	Wearer's left side seam at Hip line		



201819 2019 DENIM JEANS PANTS

### Materials

(\*) Sample size is highlighted in darker green

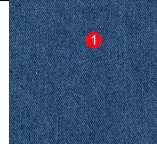
Description	DESCRIPTION	QUANTITY/ SIZE	QUALITY	PLACEMENT/POSITION	COLOR REFERENCE	BLUE
	Denim Fabric	4.8 oz Denim Blue Lightweight Fabric	1 1/2"	100% Cotton	All over the Main Body	DTM



### Measurements

#### Front Pocket Width

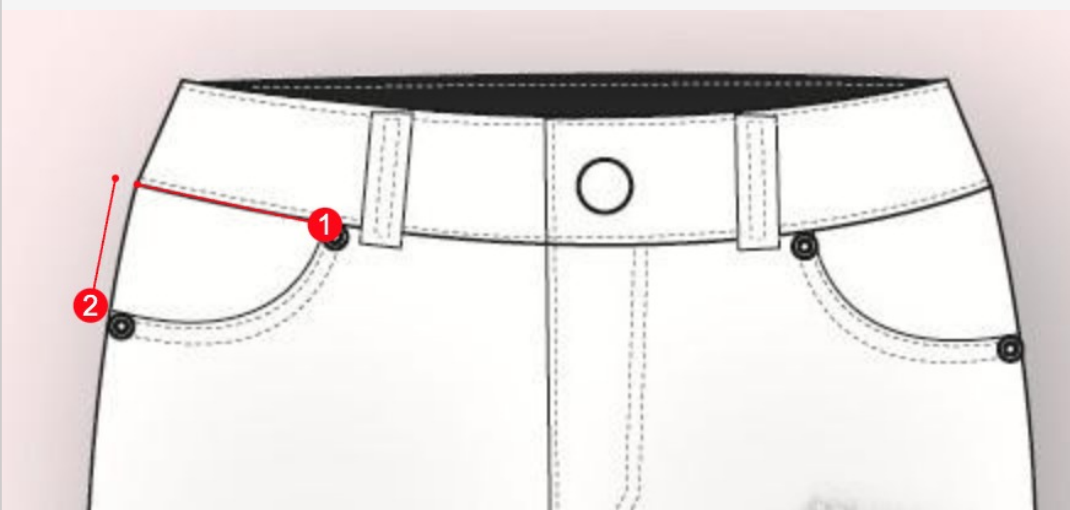

- 1 Pocket Width
- 2 Pocket Length

1. Pocket Width - Measure the width of the pocket opening from Sideseam
2. Pocket Length - Measure the Length of the Pocket opening from Sideseam

#### Belt Loop Width

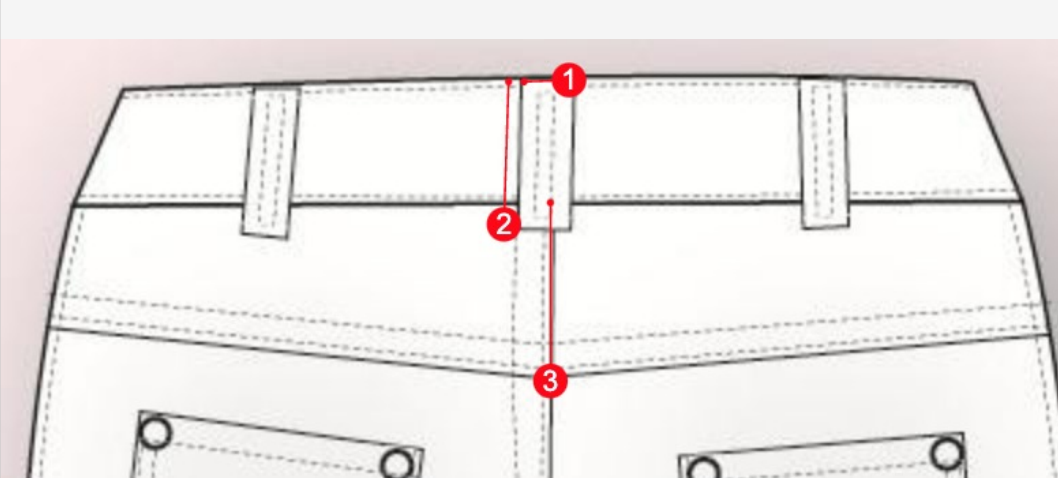

- 1 Belt Loop Width
- 2 Belt Loop Length
- 3 Back Yoke Length

1. Belt Loop Width - Measure the Width of the Belt Loop
2. Belt Loop Length - Measure the Length of the Belt Loop
3. Back Yoke Length





### Measurements

#### Waistband Width



- 1 Waistband Width
- 2 Low Waist Circumference
- 3 Hip Circumference
- 4 Total Length of the Garment
- 5 Hemline Circumference

1. Waistband - Measure along the Width of the Waistband
2. Low Waist Circumference - Measure across the garment along the waist
3. Hip Circumference - Measure across the garment along the hip
4. Total Length of the Garment - Measure the length of the garment from Neckline to the Hemline
5. Hemline Circumference - Measure along the hemline circumference

#### Back Pocket Width

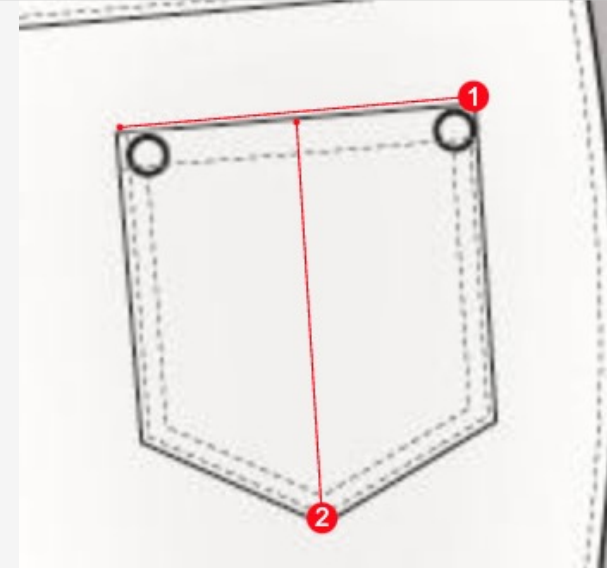

- 1 Back Pocket Width
- 2 Back Pocket Length

1. Back Pocket Width - Measure along the width of the pocket
2. Back Pocket Length - Measure along the length of the pocket



### Measurements

(\*) Sample size is highlighted in darker green

All measurements are in inches

Description	S	*M	L	TOL(+/-)
Front Pocket Width	2.5	4 1/2	2.5	1/8
Front Pocket Length	5	5	5	1/8
Belt Loop Width	0.5	1/2	0.5	1/8
Belt Loop Length	1.75	1 3/4	1.75	1/8
Back Yoke Length	4	4 1/4	4.5	1/4
Waistband Width	1.5	1 1/2	1.5	1/8
Low Waist Circumference	31	33	35	1/4
Hip Circumference	37	39	41	1/4
Total Length of the Garment	35	36	37	1/4
Hemline Circumference	8.75	9	9.25	1/4
Back Pocket Width	4.5	4 1/2	4.5	1/8
Back Pocket Length	6	6	6	1/8



### Fit Sample

#### FIT sample



- 1 Low Waist Circumference
- 2 Hip Circumference
- 3 Total length of the Garment
- 4 Front Pocket length
- 5 Back Yoke Length
- 6 Back pocket length



Fit Sample

	Point of Measurement	Eval Size M	Sample 1	Revised Spec
FIT sample	Low Waist Circumference	33	35	33
	Hip Circumference	39	40	39
	Total Length of the Garment	39	39	36
	Front Pocket Length	5	5 1/2	5
	Back Pocket Length	6	5 1/2	6
	Back Yoke Length	4	4 1/2	4 1/4



### Denim Washes and Treatment

#### Denim Washes and Treatment



- 1
- 2
- 3
- 4
- 5
- 6
- 7
- 8



### Denim Washes and Treatment

	Description	Placement
Denim Washes and Treatment	Ripping	Wearer's Right - Thigh, 2" from Side seam
	Ripping	Wearer's Left - Hip , 2" from Side seam and 8" from Waistband
	Sand blasting	Garment Front Thigh
	Sand blasting	Garment Back Seat below pockets
	Crinckle Resin 3"	Along Front Crotch
	Crinckle Resin 4"	Back Knee
	Grinding	Along Top of Scoop Pocket - Right and Left
	Ginding	Along Top of Back Patch Pocket - Right and Left